

Water Coolers and Drinking Fountains

List Price DF-43a
Effective January 1, 2005
Supersedes DF-42

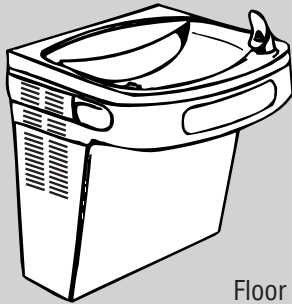

EZS8
Water Cooler
LZS8
Water Cooler
with WaterSentry[®]
Filter System

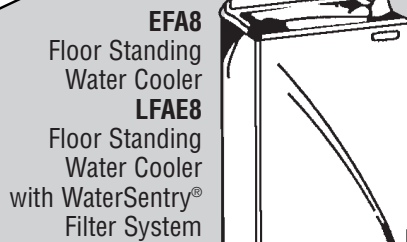

EFA8
Floor Standing
Water Cooler
LFAE8
Floor Standing
Water Cooler
with WaterSentry[®]
Filter System

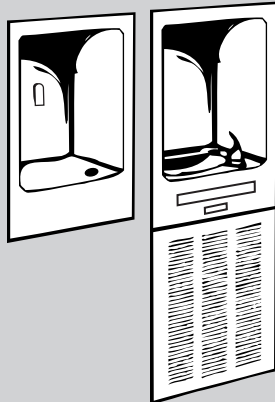

EFRPCM8K
Fully Recessed
Water Cooler
with Cuspidor

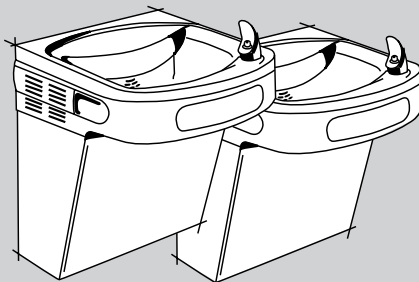

EZSTL8C
Two Level
Water Cooler

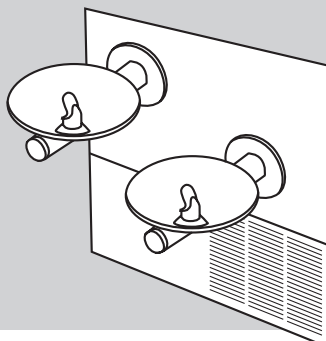

LRPBM28K
SwirlFlo[®]
Water Cooler
with WaterSentry[®]
Filter System

Includes:

- Drinking Fountains and Water Chillers
- Americans with Disabilities Act (Adult & Child ADA) Compliant Water Coolers and Drinking Fountains
- NSF/ANSI61 Section 9 Certified
- Water Coolers with WaterSentry[®] Filter System
- Universal Rough-in Coolers
- Hands-Free[®] Sensor-Operated Water Coolers
- Environmentally Friendly HFC-134A Refrigerant

TERMS AND CONDITIONS

Pricing

Prices and product specifications are subject to change without notice.

Taxes

All Federal, State or Local Taxes, when applicable, will be added.

Electronic Data Interchange (EDI)

Elkay supports the following EDI transaction sets: Inbound Purchase Orders (850), Outbound Invoices (810), Advanced Ship Notice (856), Inbound Remittance Advice (820) and Outbound Order Acknowledgement (855). Please contact Elkay's EDI Coordinator at (630) 574-8484 x2314 to discuss the list of current transaction set versions and your implementation requirements.





Warranty

A detailed warranty certificate is enclosed with each water cooler. Sample copy available on request.

TABLE OF CONTENTS AND MODEL NUMBER INDEX

TABLE OF CONTENTS		PAGE			PAGE			PAGE			PAGE
Adult & Child ADA Coolers with WaterSentry®		3	EDFP217RAC		8	ERPBM8K		5	LJNEM8K		3
Coolers with WaterSentry®		3	EDFP220RC		8	ERPBM28K		5	LJNEM12K		3
Deluxe Water Coolers with WaterSentry®		3	EDFPA17C		9	ERPBM28RAK		5	LK109A		12
Adult & Child ADA Compliant Water Coolers		4-6	EDFPA17FPK		9	ERS1		10	LK142		12
ADA Compliant Water Coolers		4-6	EDFPA17RAC		9	ERW20		10	LK1110		12
Vandal-Resistant Water Coolers		4, 6	EDFPBM114FPK		8	ERW32		10	LK1114		12
Deluxe Water Coolers		6-7	EDFPBM117FPK		8	ESRCM8		6	LK2156		12
ADA Compliant Drinking Fountains		8-9	EDFPBM114K		8	ESRCM13		6	LKAPR1		3, 5, 6, 8, 11
Drinking Fountains		9-10	EDFPBM117K		8	ESRDCM		6	LKAPR188S		4, 11
Water Chillers		10	EDFPBM117RAK		8	ESRWC8		6	LKAPR1512		3, 5, 9, 11
Accessories		11-12	EDFPBWM114K		8	ESRWC13		6	LKAPREZL		3, 4, 11
Filters		12	EFA4		6	ESWA8		6	LKFEAM8K		3
			EFA8		6	ESWA13		6	LKTEAM8K		3
			EFA14		6	ESWDA		6	LKTEAM8RAK		3
			EFA16		6	EWA4		7	LL67114		6
			EFA20		6	EWA8		7	LNEM8K		3
			EFA25		6	EWA14		7	LNTEM8K		3
			EFAVR14		6	EWA16		7	LNTEM8RAK		3
			EFDA		6	EWA20		7	LRPBM8K		3
			EFHA8		6	EWCA4		7	LRPBM28K		3
			EFHA14		6	EWCA8		7	LRPBM28RAK		3
			EFOA8		6	EWCA14		7	LWAE8		3
			EFRCM8K		5	EWGDA		7	LWCE4		3
			EFRCM8CDK		5	EWDA		7	LWCE8		3
			EFRCM12K		5	EWV172		12	LZ8		3
			EFRCM12CDK		5	EWHA8		7	LZS8		3
			EFRPCM8K		5	EWHA14		7	LZSTL8C		3
			EFTLA8K		6	EWTLA8K		7	LZTL8C		3
			EFTLA14K		6	EWTLA14CK		7	MB11		11
			EFW16		6	EWTLA16K		7	MB20		11
			EFWC16		6	EZ4		4	MB23A		11
			EFY8		7	EZ8		4	MB23AL		11
			EG1		11	EZD		4	MB24		11
			EG2		11	EZO4		4	MB30		11
			EG3		11	EZO8		4	MF100		11
			EHFA8		4	EZOSTL8C		4	MF200		11
			EHFAD		4	EZS4		4	MFC100		11
			EHFRAM7K		5	EZS8		4	MP20		11
			EHFSA8		4	EZSD		4	MP20RA		11
			EHFSAD		4	EZSTL8C		4	MP85		11
			EHOA8		4	EZSTLDDC		4	MP86		11
			ENOBM28K		6	EZSTLR8C		4	OBFAVR8		4
			ENOBM28RAK		6	EZSTLRDDC		4	OBFAVRD		4
			ENOBM8K		6	EZTL8C		4	OBFAVFRFR8		4
			ER2		10	EZTLR8C		4	OBFATL8C		4
			ER5		10	FD7001		7	OBFATLR8C		4
			ER10		10	FD7003		7	OFA25		6
			ER19		10	FD7005		7	OFAVR14		6
			ER30		10	FD7008		7	OFAVFRFR14		6
			ERC8		10	FD70010		7	OHFAVR8		4
			ERFPM8K		5	FD700D		7	PM3		11
			ERFPM28K		5	FGDF7105		7	PM4		11
			ERFPM28RAK		5	FGDF71010		7	RP2130		3, 4, 11
			ERHPAM8K		5	HEW1		7	WD7015		7
			ERHPAM28K		5	HEW3		7	WD7018		7
			ERHPAM28RAK		5	HEW5		7	WGA7115		7
			EROM28K		5	HEWD		7	WGA71110		7
			EROM28RAK		5	LFAE8		3	WP1		11
			EROM8K		5	LFDE8		3	WP2		11

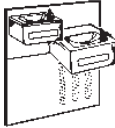
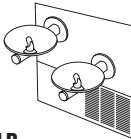
Elkay Water Coolers with WaterSentry® Filter System

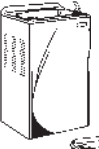
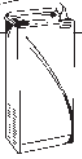
	MODEL NUMBER	FEATURES/OPTIONS	GPH. CAP.	SHIP WT. LBS.	SUG. LIST PRICE
Adult or Child ADA Compliant 	LZS8*	Easy-Touch Controls front and both sides	8.0	59	\$799.50
	LZ8*	Easy-Touch Control front only	8.0	59	\$788.50
	RP2130	Stainless steel lower shroud, add Wall bezel, optional accessory (see page 11)	-	4	\$81.25 \$96.50
LZ					
	LZSTL8C*	Two level, front and side Easy-Touch Controls, higher unit on the left	8.0	88	\$1,385.50
	LZTL8C*	Two level, front only Easy-Touch Control, higher unit on the left	8.0	88	\$1,363.50
		Stainless steel lower shroud, add			\$162.00
	LKAPREZL	Apron, optional accessory only available in gray (see page 11)	-	2	\$99.25
LZTL					
Adult ADA Compliant 	LKFEAM8K*	One level, kit contains fountain body, ECH8 chiller, MF100 mounting frame and WaterSentry® Filter System	7.5	100	\$2,485.00
	LKTEAM8K*	Two level, kit contains fountain body, ECH8 chiller, MF200 mounting frame and WaterSentry® Filter System, higher unit on the left	7.5	143	\$3,733.75
	LKTEAM8RAK*	Two level, kit contains fountain body, ECH8 chiller, MF200 mounting frame and WaterSentry® Filter System, higher unit on the right	7.5	143	\$3,733.75
	LKAPR1512	Apron, optional accessory (see page 11)	-	13	\$220.75
		CP10 bottom cover plate, add	-	3	\$50.75
	CP14 bottom cover plate, add	-	3	\$75.75	
LK					
Soft Sides® 	LNFEM8K*	Soft Sides®, one level, kit contains fountain body, ECH8 chiller, MF100 mounting frame and WaterSentry® Filter System	7.5	98	\$2,485.00
	LNTEM8K*	Soft Sides®, two level, kit contains fountain body, ECH8 chiller, MF200 mounting frame and WaterSentry® Filter System, higher unit on the left	7.5	133	\$3,733.75
	LNTEM8RAK*	Soft Sides®, two level, kit contains fountain body, ECH8 chiller, MF200 mounting frame and WaterSentry® Filter System, higher unit on the right	7.5	133	\$3,733.75
	97258C	Apron, optional accessory only available in black (see page 11)	-	5	\$110.75
LN					
SwirlFlo® 	LRPBM8K	SwirlFlo®, one level, kit contains fountain body, ECH8 chiller, MF100 mounting frame and WaterSentry® Filter System	7.5	96	\$2,672.25
	LRPBM28K	SwirlFlo®, two level, kit contains fountain body, ECH8 chiller, MF200 mounting frame and WaterSentry® Filter System, higher unit on left	7.5	143	\$4,287.75
	LRPBM28RAK	SwirlFlo®, two level, kit contains fountain body, ECH8 chiller, MF200 mounting frame and WaterSentry® Filter System, higher unit on right	7.5	143	\$4,287.75
	LKAPR1	Apron, optional accessory only available in gray (see page 11)	-	5	\$110.75
LR					
	LJNEM8K*	Fully recessed, kit contains fountain body, ECP8 refrigeration package and MB23AL mounting box and WaterSentry® Filter System	8.0	107	\$2,300.50
	LJNEM12K* [§]	Fully recessed, kit contains fountain body, ECP8 refrigeration package and MB23AL mounting box and WaterSentry® Filter System	12.0	108	\$2,397.25
LJ					
Deluxe 	LWAE8*	Wall	8.0	74	\$1,128.25
		Stainless steel cabinet, add			\$131.25
	LWCE4*	Wall compact	4.0	59	\$994.50
		Stainless steel cabinet, add			\$111.00
	LWCE8*	Wall compact	8.0	68	\$1,136.50
		Stainless steel cabinet, add			\$111.00
LW					
	LFAE8*	Floor, Light Gray	8.0	83	\$1,109.25
		Stainless steel cabinet, add			\$200.25
	LFDE8*	Floor compact, Sandalwood	8.0	63	\$1,022.00
	Stainless steel cabinet, add			\$200.25	
LF					
Filter Monitor Kit	92640C*	Filter monitor kit – For water coolers with WaterSentry® Filter System. Filter monitor counts gallon usage and provides audible alert when filter needs replacement.	-	1	\$190.00

 ADA compliant when properly installed. See specification sheet for details.

[§] Complies only with the lead-free definition of ANSI/NSF61, Section 9.







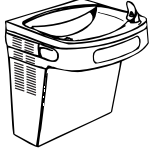

Please contact your ELKAY representative to answer any questions regarding model specification, the WaterSentry Filter System and delivery or check our website at www.elkayusa.com.

Special electrical requirements

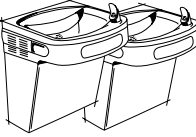
Some models available for use with 220-240 voltage. Consult with Elkay Customer Service when ordering to specify frequency. Models with * are **NOT** available in 220-240 volt. Add for above

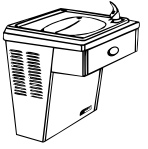
SUG. LIST PRICE
\$44.00

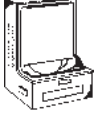

Elkay Water Coolers

	MODEL NUMBER	FEATURES/OPTIONS	GPH. CAP.	SHIP WT. LBS.	SUG. LIST PRICE	
Adult or Child ADA Compliant  	EZS4*	Easy-Touch Controls front and both sides	4.0	58	\$696.50	
	EZS8	Easy-Touch Controls front and both sides	8.0	58	\$707.50	
	EZSD*	Easy-Touch Controls front and both sides – non-refrigerated (requires electric plug in)	–	30	\$539.50	
	EZ4*	Easy-Touch Control front only	4.0	58	\$685.50	
	EZ8*	Easy-Touch Control front only	8.0	58	\$696.50	
	EZD*	Easy-Touch Control front only – non-refrigerated (requires electric plug in)	–	30	\$521.75	
	EZO4*	Sensor-operated, Hands-Free® Control	4.0	58	\$1,053.00	
	EZO8	Sensor-operated, Hands-Free® Control	8.0	58	\$1,064.00	
	EZ		Stainless steel lower shroud, add			\$81.25
			Mirror stainless steel basin and lower shroud, add			\$275.50
EZO coolers include infra-red light beam sensor that activates a solenoid valve which opens and allows water to flow. No contact with cooler required. Time delay prevents activation by passerby.						
Adult or Child ADA Compliant  	EZSTL8C*	Two level, front and side Easy-Touch Controls, higher unit on the left	8.0	88	\$1,293.50	
	EZTL8C*	Two level, front only Easy-Touch Control, higher unit on the left	8.0	88	\$1,271.50	
	EZSTLR8C*	Two level, front and side Easy-Touch Controls, higher unit on the right	8.0	88	\$1,293.50	
	EZTLR8C*	Two level, front only Easy-Touch Control, higher unit on the right	8.0	88	\$1,271.50	
	EZSTLDDC*	Two level, front and side Easy-Touch Controls, higher unit on the left – both non-refrigerated (requires electric plug in)	–	61	\$1,176.00	
	EZSTLRDDC*	Two level, front and side Easy-Touch Controls, higher unit on the right – both non-refrigerated (requires electric plug in)	–	61	\$1,176.00	
	EZOSTL8C*	Two level, sensor operated Hands-Free® Control on lower unit, front and side Easy-Touch Controls on upper unit on the left	8.0	88	\$1,661.25	
			Stainless steel lower shroud, add			\$162.00
			Mirror stainless steel basin and lower shroud, add			\$551.25
		LKAPREZL	Apron, optional accessory only available in gray (see page 11)	–	2	\$99.25
Vandal-Resistant ADA Compliant  	OBFAVR8	Vandal-resistant, indoor/outdoor (Stainless Steel cabinet only) Vandal-resistant coolers feature heavy duty push buttons and stainless steel cabinets. Louver screening and vandal-resistant screws guard against vandalism.	8.0	74	\$1,258.75	
	OBFAVRD*	Vandal-resistant, indoor/outdoor – non-refrigerated (Stainless Steel cabinet only)	–	35	\$1,096.50	
	OBFAVRFR8*	Vandal-resistant, indoor/outdoor with frost resistant heat strip (Stainless Steel cabinet only)	8.0	74	\$1,810.00	
	OBFATL8C*	Two station push-button, vandal-resistant, indoor/outdoor higher unit on left (Stainless Steel cabinet only)	8.0	94	\$2,374.00	
	OBFATLR8C*	Two station push-button, vandal-resistant, indoor/outdoor higher unit on right (Stainless Steel cabinet only)	8.0	94	\$2,374.00	
	LKAPR188S	Apron, optional accessory in stainless steel (see page 11)	–	3	\$93.50	
	RP2130	Wall bezel, optional (see page 11)	–	4	\$96.50	
	OBFATL		Universal back-of-unit configuration allows adaption as replacement cooler to most incoming plumbing arrangements. Applies to EZ, EZD, EZS, EZSD and OBFAVR.			
Adult ADA Compliant  	EHFA8*	Pushbar front only	7.6	69	\$751.50	
	EHFSA8*	Pushbar front and both sides	7.6	72	\$771.75	
	EHFAD*	Pushbar front only – non-refrigerated	–	30	\$582.75	
	EHFSAD*	Pushbar front and both sides – non-refrigerated	–	31	\$728.25	
	EHOA8*	Sensor-operated	7.6	72	\$1,119.00	
	EHFA		Stainless steel cabinet, add			\$81.25
Vandal-Resistant ADA Compliant  	OHFAVR8*	Vandal-resistant, indoor/outdoor (Stainless Steel cabinet only) Vandal-resistant coolers feature heavy duty push buttons and stainless steel cabinets. Louver screening and vandal-resistant screws guard against vandalism.	7.6	78	\$1,302.75	
	OHFA					

 ADA compliant when properly installed. See specification sheet for details.

* Not available in 220-240 volt.

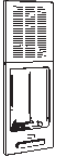
Elkay Water Coolers

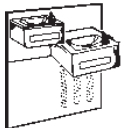
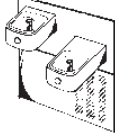
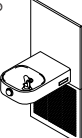
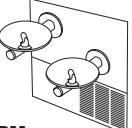



	MODEL NUMBER	FEATURES/OPTIONS	GPH. CAP.	SHIP WT. LBS.	SUG. LIST PRICE
Adult ADA Compliant  	EHFRAM7K*	Fully recessed, kit contains fountain body, ECP8 refrigeration package and MB30 mounting box	6.9	121	\$2,482.75
	EHFRAM				
	EFRMCM8K*	Fully recessed, kit contains fountain body, ECP8 refrigeration package and MB23A mounting box	8.0	149	\$2,205.00
	EFRMCM12K* [§]	Fully recessed, kit contains fountain body, ECP8 refrigeration package and MB23A mounting box	12.0	149	\$2,301.75
	EFRMCM8CDK*	Fully recessed, cup dispenser/disposer, kit contains fountain body with cup dispenser/disposer, ECP8 refrigeration package and MB23A mounting box	8.0	178	\$3,936.50
	EFRMCM12CDK* [§]	Fully recessed, cup dispenser/disposer, kit contains fountain body with cup dispenser/disposer, ECP8 refrigeration package and MB23A mounting box	12.0	178	\$4,022.75
	EFRMCM				
	ERHPAM8K*	One level, kit contains fountain body, ECH8 chiller and MF100 mounting frame	7.5	97	\$2,390.25
	ERHPAM28K*	Two level, kit contains fountain body, ECH8 chiller and MF200 mounting frame, higher unit on the left	7.5	140	\$3,639.00
	ERHPAM28RAK*	Two level, kit contains fountain body, ECH8 chiller and MF200 mounting frame, higher unit on the right	7.5	140	\$3,639.00
	LKAPR1512	Apron, optional accessory (see page 11)	–	13	\$220.25
		CP10 bottom cover plate, add	–	3	\$50.75
	CP14 bottom cover plate, add	–	3	\$75.75	
ERHPAM					
Adult ADA Compliant Soft Sides® 	ERFPM8K	Soft Sides®, one level, kit contains fountain body, ECH8 chiller and MF100 mounting frame	7.5	95	\$2,390.25
	EROM8K	Soft Sides®, one level, sensor-operated, kit contains fountain body, ECH8 chiller and MF100 mounting frame	7.5	97	\$2,773.00
	ERFPM28K	Soft Sides®, two level, kit contains fountain body, ECH8 chiller and MF200 mounting frame, higher unit on the left	7.5	130	\$3,639.00
	ERFPM28RAK*	Soft Sides®, two level, kit contains fountain body, ECH8 chiller and MF200 mounting frame, higher unit on the right	7.5	130	\$3,639.00
	EROM28K	Soft Sides®, two level, sensor-operated, kit contains fountain body, ECH8 chiller and MF200 mounting frame, higher unit on the left	7.5	130	\$4,021.75
	EROM28RAK*	Soft Sides®, two level, sensor-operated, kit contains fountain body, ECH8 chiller and MF200 mounting frame, higher unit on the right	7.5	130	\$4,021.75
	97258C	Apron, optional accessory only available in black (see page 11)	–	5	\$110.75
	ERFPM				
Child ADA Compliant Slim Line® 	ECRSPM8K	Slim Line®, one level, kit contains fountain body, ECH8 chiller and MFC100 mounting frame	7.5	128	\$2,458.75
	ECRSPM				
Adult ADA Compliant SwirlFlo® 	ERPBM8K	SwirlFlo®, one level, kit contains fountain body, ECH8 chiller and MF100 mounting frame	7.5	93	\$2,564.00
	ERPBM28K	SwirlFlo®, two level, kit contains fountain body, ECH8 chiller and MF200 mounting frame, higher unit on the left	7.5	140	\$4,193.00
	ERPBM28RAK	SwirlFlo®, two level, kit contains fountain body, ECH8 chiller and MF200 mounting frame, higher unit on the right	7.5	140	\$4,193.00
	LKAPR1	Apron, optional accessory only available in gray (see page 11)	–	5	\$110.75
	ERPBM				

 ADA compliant when properly installed. See specification sheet for details.

*Not available in 220-240 volt.

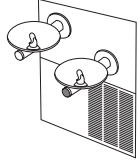
[§] Complies only with the lead-free definition of ANSI/NSF61, Section 9.

Elkay Water Coolers

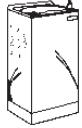
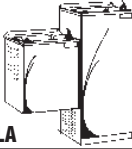



	MODEL NUMBER	FEATURES/OPTIONS	GPH. CAP.	SHIP WT. LBS.	SUG. LIST PRICE	
Adult ADA Compliant  SwirlFlo® 	ENOBM8K	New SwirlFlo®, one level, sensor-operated, kit contains fountain body, ECH8 chiller and MF100 mounting frame	7.5	93	\$2,946.75	
	ENOBM28K	New SwirlFlo®, two level, sensor-operated, kit contains fountain body, ECH8 chiller and MF200 mounting frame, higher unit on the left	7.5	140	\$4,575.50	
	ENOBM28RAK	New SwirlFlo®, two level, sensor-operated, kit contains fountain body, ECH8 chiller and MF200 mounting frame, higher unit on the right	7.5	140	\$4,575.50	
	LKAPR1	Apron, optional accessory only available in gray (see page 11)	-	5	\$110.75	
Adult ADA Compliant  ESRCM 	ESRCM8*	Semi-recessed with MB20 mounting box	7.8	86	\$1,475.00	
	ESRCM13*§	Semi-recessed with MB20 mounting box	12.6	92	\$1,554.25	
	ESRDCM*	Semi-recessed with MB20 mounting box – non-refrigerated	-	65	\$786.75	
	ESRWC8*	Semi-recessed without MB20 mounting box	7.8	68	\$1,427.25	
	ESRWC13*§	Semi-recessed without MB20 mounting box	12.6	72	\$1,494.75	
		Stainless steel wrapper, add			\$89.50	
ESWA 	ESWA8	Simulated semi-recessed	7.8	60	\$1,294.50	
	ESWA13§	Simulated semi-recessed	12.6	68	\$1,417.00	
	ESWDA*	Simulated semi-recessed – non-refrigerated	-	35	\$666.25	
		Stainless steel wrapper, add			\$89.50	
Deluxe 	EFA4*	Floor, air cooled	4.0	75	\$898.00	
	EFA8	Floor, air cooled	8.0	78	\$1,014.50	
	EFA14	Floor, air cooled	13.5	81	\$1,062.50	
	EFA16§	Floor, air cooled	15.5	87	\$1,272.25	
	EFA20§	Floor, air cooled	19.5	85	\$1,315.75	
	EFDA*	Floor – non-refrigerated	-	55	\$502.50	
	EFW16*	Floor, water cooled	16.0	82	\$1,423.00	
	EFWC16*	Floor, corrosion-resistant, water cooled	16.0	85	\$1,873.75	
	EFHA8	Floor with hot and cold service	8.0	90	\$1,449.75	
	EFHA14	Floor with hot and cold service	13.5	93	\$1,537.50	
		Foot pedal, add*	-	4	\$69.75	
		Stainless steel panels, add			\$200.25	
		EFOA8*	Sensor-operated	8.0	81	\$1,393.25
	Vandal-Resistant	EFAVR14	Vandal-resistant, indoor unit (Stainless Steel cabinet only)	13.5	82	\$1,562.50
OFAVR14		Vandal-resistant, outdoor unit, complete with plumbing box and back panel (Stainless Steel cabinet only)	13.5	99	\$1,656.00	
OFAVRFR14*		Vandal-resistant outdoor unit with frost resistant heat strip, complete with plumbing box and back panel	13.5	99	\$1,911.75	
Vandal-resistant coolers feature heavy duty push buttons and stainless steel cabinets. Louver screening and vandal-resistant screws guard against vandalism.						
High Capacity	EFA25§	High ambient, high capacity, indoor unit (Stainless Steel cabinet only)	25.0	102	\$2,192.50	
	OFA25§	High ambient, high capacity, outdoor unit, complete with plumbing box and back panel (Stainless Steel cabinet only)	25.0	90	\$2,394.50	
EFA/OFA 	LL67114*	Floor, low level	13.5	84	\$1,181.00	
		Stainless steel panels, add			\$145.00	
LL67114 Deluxe 	EFTLA8K*	Floor, two level, kit contains refrigerated half and non-refrigeration half	8.0	119	\$1,583.75	
	EFTLA14K*	Floor, two level, kit contains refrigerated half and non-refrigeration half	13.5	120	\$1,614.00	
		Foot pedal, add	-	4	\$69.75	
		Stainless steel panels, add			\$293.50	
EFTLA						

 ADA compliant when properly installed. See specification sheet for details.

*Not available in 220-240 volt.

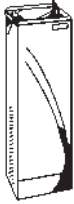
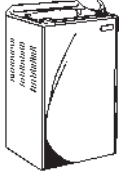
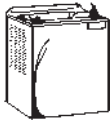
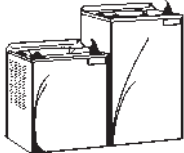
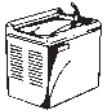
§ Complies only with the lead-free definition of ANSI/NSF61, Section 9.

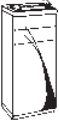
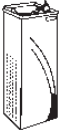





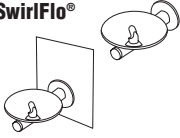
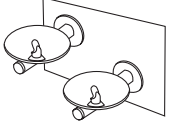

Elkay No Lead Water Coolers

	MODEL NUMBER	FEATURES/OPTIONS	GPH. CAP.	SHIP WT. LBS.	SUG. LIST PRICE	
Standard 	FD7001	Floor, Sandalwood	1.0	55	\$749.75	
	FD7003	Floor, Sandalwood	2.8	57	\$812.25	
	FD7005	Floor, Sandalwood	5.0	63	\$896.00	
	FD7008	Floor, Sandalwood	8.0	59	\$927.25	
	FD70010	Floor, Sandalwood	9.8	68	\$1,021.25	
	FD700D*	Floor, Sandalwood – non-refrigerated	–	35	\$429.25	
		Stainless steel panels, add			\$200.25	
FD Deluxe 	EWA4*	Wall mounted	4.0	66	\$1,004.00	
	EWA8	Wall mounted	8.0	70	\$1,033.25	
	EWA14	Wall mounted	13.5	72	\$1,106.75	
	EWA16 [§]	Wall mounted	15.5	76	\$1,189.50	
	EWA20 [§]	Wall mounted	19.5	74	\$1,413.00	
	EWDA*	Wall mounted – non-refrigerated	–	44	\$415.25	
	EWHA8	Wall mounted with hot and cold service	8.0	82	\$1,414.25	
	EWHA14	Wall mounted with hot and cold service	13.5	85	\$1,533.00	
		Stainless steel panels, add			\$131.50	
	EWA 	EWCA4	Wall compact	4.0	59	\$899.75
		EWCA8	Wall compact	8.0	64	\$1,041.75
		EWCA14	Wall compact	13.5	68	\$1,139.75
EWCA14*		Wall compact – non-refrigerated	–	28	\$396.00	
		Stainless steel panels, add			\$131.50	
EWCA 	EWTLA8K*	Wall two level, kit contains refrigerated half and non-refrigerated half	8.0	108	\$1,468.50	
	EWTLA14K*	Wall two level, kit contains refrigerated half and non-refrigerated half	13.5	112	\$1,550.75	
	EWTLA16K*	Wall two level, kit contains refrigerated half and non-refrigerated half	15.5	112	\$1,573.00	
		Stainless steel panels, add			\$238.75	
EWTLA Standard 	HEW1	Wall compact slant front, Sandalwood	1.0	45	\$840.25	
	HEW3	Wall compact slant front, Sandalwood	3.0	48	\$909.50	
	HEW5*	Wall compact slant front, Sandalwood, 115V/60 Hz only	4.6	48	\$965.00	
	HEWD*	Wall compact slant front – non-refrigerated, Sandalwood	–	26	\$528.00	
		Stainless steel panels, add			\$98.25	
	HEW 	WD7015*	Wall, Sandalwood	5.0	55	\$991.25
WD7018*		Wall, Sandalwood	8.0	55	\$1,157.00	
		Stainless steel panels, add			\$187.75	
WD 	EFY8*	Explosion proof – see specifications sheet for details	8.0	80	\$2,504.25	
	EFY 	FGDF7105*	Government type, floor	5.0	64	\$1,092.75
FGDF71010*		Government type, floor	9.8	63	\$1,170.25	
		Stainless steel panels, add			\$151.75	
FGDF 	WGA7115*	Government type, wall	8.0	72	\$1,124.00	
	WGA					

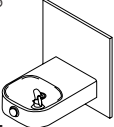
*Not available in 220-240 volt.

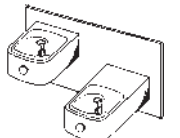
§ Complies only with the lead-free definition of ANSI/NSF61, Section 9.

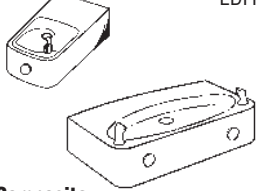



Elkay No Lead Drinking Fountains

	MODEL NUMBER	FEATURES/OPTIONS	GPH. CAP.	SHIP WT. LBS.	SUG. LIST PRICE
ADA Compliant 	EDFPBM114K	SwirlFlo®, one level, kit contains MP86 in-the-wall mounting plate	–	33	\$1,601.00
SwirlFlo® 	EDFPBWM114C	SwirlFlo®, one level, complete with surface mounting plate and stainless steel wall plate	–	35	\$1,736.75
	EDFPBM114FPK	SwirlFlo®, one level, freeze-resistant kit contains fountain, freeze-resistant box and mounting plate.	–	46	\$2,152.25
114 Series					
SwirlFlo® 	EDFPBM117C	SwirlFlo®, two level, complete with surface mounting plate and stainless steel wall plate, higher unit on left	–	77	\$2,730.75
	EDFPBM117RAC	SwirlFlo®, two level, complete with surface mounting plate and stainless steel wall plate, higher unit on right	–	77	\$2,730.75
	EDFPBM117FPK	SwirlFlo®, two level, freeze-resistant kit contains fountain, freeze-resistant box, wall and mounting plates	–	113	\$3,833.00
	LKAPR1	Apron, optional accessory only available in gray (see page 11)	–	5	\$110.75
117 Series					
Child ADA Compliant 	ECDFPW314C	Wall, one level, barrier-free, complete with mounting plate and stainless steel wall plate	–	28	\$1,218.25
Slim Line® 					
ECDFPWW					
Soft Sides® 	EDFP214C	Wall, one level, barrier-free	–	20	\$921.75
		WP2 stainless steel wall plate, add	–	3	\$111.25
		MP86 mounting plate, add	–	5	\$120.00
	EDFP214FPK	Freeze-resistant model. Kit contains fountain and freeze-resistant box	–	41	
214 Series					
Adult ADA Compliant 	EDFP217C	Wall, two level, barrier-free, pushbutton control complete with stainless steel wall plate, higher unit on the left	–	48	\$1,859.00
Soft Sides® 		MP20 mounting plate, add	–	24	\$202.75
	EDFP217RAC	Wall, two level, barrier-free, pushbutton control, complete with stainless steel wall plate, higher unit on the right	–	48	\$1,859.00
		MP20RA mounting plate, add	–	24	\$202.75
	EDFP217FPK	Freeze-resistant model. Kit contains fountain and freeze-resistant boxes complete with stainless steel wall plate, higher unit on the left	–	98	\$2,961.75
		MP20 mounting plate, add	–	10	\$202.75
	97258C	Apron, optional accessory only available in black (see page 11)	–	5	\$110.75
217 Series					
Composite ADA Compliant 	EDFP214RC	Premium composite material, wall, barrier-free, pushbutton control White Granite color	–	35	\$921.75
Soft Sides® 		MP86 mounting plate, add	–	5	\$120.00
	EDFP220RC	Two station premium composite material, wall, barrier-free, pushbutton control. White granite color	–	70	\$1,996.50
Composite					
Adult ADA Compliant 	EDFP14C	Wall, barrier-free, pushbar control	–	19	\$917.50
14 Series 		CP14 bottom cover plate, add	–	3	\$75.75
		WP1 stainless steel wall plate, add	–	4	\$110.75
		MP85 mounting plate, add	–	5	\$120.00
	EDFP14FPK	Freeze-resistant model. Kit contains fountain and freeze-resistant box	–	36	\$1,468.75

 ADA compliant when properly installed. See specification sheet for details.

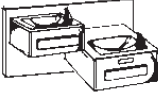
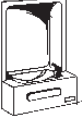

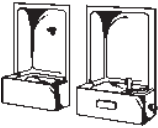
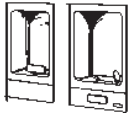
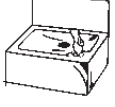



*Not available in 220-240 volt.

Elkay Drinking Fountains

	MODEL NUMBER	FEATURES/OPTIONS	GPH. CAP.	SHIP WT. LBS.	SUG. LIST PRICE
Adult ADA Compliant 	EDFPA17C	Wall, two level, barrier-free, pushbar control complete with stainless steel wall plate, higher unit on the left MP20 mounting plate, add	–	54	\$1,969.75 \$202.75
	EDFPA17RAC	Wall, two level, barrier-free, pushbar control complete with stainless steel wall plate, higher unit on the right MP20RA mounting plate, add	–	54	\$1,969.75 \$202.75
 17 Series	EDFPA17FPK	Freeze-resistant model. Kit contains fountain and freeze-resistant boxes, complete with stainless steel wall plate, higher unit on the left MP20 mounting plate, add	–	96	\$3,072.25 \$202.75
	LKAPR1512	Apron, optional accessory (see page 11) CP10 bottom cover plate, add CP14 bottom cover plate, add	– – –	13 3 3	\$220.25 \$50.75 \$75.75
 EDFA	EDFA11C	Wall, semi-recessed with CP11 bottom cover plate MB11 mounting box, add	– –	28 8	\$1,187.25 \$88.50
	EDFA11FPK	Freeze-resistant model. Kit contains fountain and freeze-resistant box MB11 mounting box, add	– –	44 8	\$1,738.50 \$88.50
 EDFB	EDFB12C	Wall, fully recessed MB24 mounting box, add	– –	27 10	\$1,173.00 \$86.25
	EDFB12FPK	Freeze-resistant model. Kit contains fountain and freeze-resistant box MB24 mounting box, add	– –	50 10	\$1,724.25 \$86.25
 19 Series	EDFP19C	Wall, simulated semi-recessed with pushbar	–	21	\$772.75
	EDFAC211C	Wall, simulated semi-recessed fountain/cuspidor MB11 mounting box, add per box (2) mounting boxes required CP11 bottom cover plate, (2) cover plates required, add per plate	– – –	56 8 2	\$2,793.00 \$88.50 \$60.50
 11 Series	EDFAC11PBC	Cuspidor only with pushbar control. Does not include fountain, mounting box or bottom cover plate	–	26	\$1,708.00
	EDFBC212C	Wall, fully recessed fountain/cuspidor MB24 mounting box, add per box (2) mounting boxes required	– –	56 10	\$2,404.25 \$86.25
 12 Series	EDFBC12PBC	Cuspidor only with pushbar control. Does not include fountain, mounting box or bottom cover plate	–	30	\$1,333.50
	Drinking Fountains Freeze-Resistant   10 Series	EDF10C	Wall, fully exposed CP10 bottom cover plate with LK464 drain and trap, add	– –	13 4
EDFP10C		Wall CP10 bottom cover plate, add WP1 stainless steel wall plate, add MP85 mounting plate, add	– – – –	16 3 4 5	\$696.75 \$50.75 \$110.75 \$120.00
EDFP10FPK		Freeze-resistant model. Kit contains fountain and freeze-resistant box	–	37	\$1,248.00

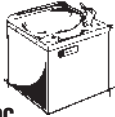
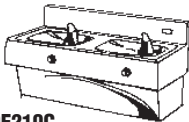
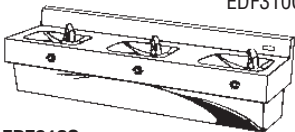
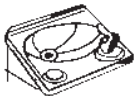
 ADA compliant when properly installed. See specification sheet for details.

Elkay Drinking Fountains and Water Chillers

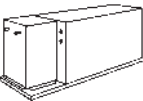



	MODEL NUMBER	FEATURES/OPTIONS	GPH. CAP.	SHIP WT. LBS.	SUG. LIST PRICE
Drinking Fountains 	EDF14C	Wall, barrier-free	-	14	\$789.25
		CP14 bottom cover plate, add	-	3	\$75.75
		WP1 stainless steel wall plate, add	-	4	\$110.75
		MP85 mounting plate, add	-	5	\$120.00
EDF14C					
	EDFP210C	Wall, one level, pushbutton control	-	14	\$795.50
		WP2 stainless steel wall plate, add	-	2	\$110.75
		MP86 mounting plate, add	-	5	\$120.00
	EDFP210FPK	Freeze-resistant model. Kit contains fountain and freeze-resistant box	-	38	\$1,346.75
EDFP					
Composite	EDFP210RC	Premium composite material, wall, pushbutton control	-	30	\$819.25
Soft Sides® 		White Granite color			
		MP86 mounting plate, add	-	5	\$120.00
	EDF214WC	Standard composite material, wall, complete with LK142 bubbler	-	50	\$512.00
		White color only			
		MP86 mounting plate, add	-	5	\$120.00
EDF					
Drinking Fountains	EDF20C	Wall mount	-	11	\$426.50
					
EDF20C					
	EDF210C	Wall, two station	-	33	\$2,216.50
		CP210 bottom cover plate, add	-	4	\$157.75
EDF210C					
	EDF310C	Wall, three station	-	51	\$2,652.00
		CP310 bottom cover plate, add	-	6	\$240.00
EDF310C					
	EDF15AC	Post mount	-	5	\$202.75
EDF15AC					
	DRKR10C	Countertop	-	5	\$266.50
	DRKR14C	SwirlFlo countertop	-	7	\$559.00
	DRKR14RC	SwirlFlo countertop remote pushbutton	-	8	\$822.25
DRKR					
Water Chillers	ERS1	Air cooled, stainless waterway	1.5	37	\$724.50
	ER2	Air cooled	2.5	48	\$841.00
	ER5	Air cooled	5.7	72	\$1,174.25
	ECH8	Air cooled	8.0	47	\$1,064.50
	ERC8*	Air cooled	8.0	53	\$1,028.25
	ER10	Air cooled	9.6	76	\$1,255.00
	ER19	Air cooled	19.0	100	\$1,785.00
	ER30	Air cooled	28.0	121	\$2,025.00
	ERW20*	Water cooled	19.5	100	\$1,953.25
	ERW32*	Water cooled	31.9	120	\$2,302.75
					
ER		Note: Remote chillers ER5, ER10 & ER19 adjustable to 68°F.			

*Not available in 220-240 volt.



Elkay Accessories

	MODEL NUMBER	FEATURES/OPTIONS	GPH. CAP.	SHIP WT. LBS.	SUG. LIST PRICE
Accessories	EG1	Louvered grill	–	8	\$254.25
	EG2	Louvered grill	–	8	\$163.50
	EG3	Louvered grill	–	10	\$188.75
EG					
Unless otherwise indicated, mounting boxes, frames and plates are included with base cooler price	MB11 [†]	Mounting box used on EDFA11C, EDFAC11PBC and EDFAC211C	–	8	\$88.50
	MB20	Mounting box used on ESRCM8 and ESRCM13	–	20	\$158.25
	MB23A	Mounting box used on EFRCM8K, EFRCM12K, and EFRPCM8K	–	36	\$191.50
	MB23AL	Mounting box used on LJNEM8K and LJNEM12K	–	37	\$234.00
	MB24	Mounting box used on EFRPCM8K	–	10	\$86.25
	MB24 [†]	Mounting box used on EDFB12C, EDFBC12PBC and EDFBC212C	–	10	\$86.25
	MB	MB30	Mounting box used on EHFRAM7K	–	37
	MF100	Mounting frame used on LKFEM8K, LNFEM8K, LPFEM8K, LRPBM8K, ERHPAM8K, ERFPM8K, EROM8K, ERPBM8K, and ENOBM8K	–	19	\$144.75
	MFC100	Mounting frame used on ECRSPM8K, ECRSPVRM8K and LCRSPM8K	–	19	\$144.75
MF	MF200	Mounting frame used on LKTEAM8K, LKTEAM8RAK, LNTEM8K, LNTEM8RAK, LPTEAM8K, LPTEAM8RAK, LRPBM28K, LRPBM28RAK, ERHPAM28K, ERHPAM28RAK, ERFPM28K, ERFPM28RAK, EROM28K, EROM28RAK, ERPBM28K, ERPBM28RAK, ENOBM28K, and ENOBM28RAK	–	32	\$231.50
	MP20	Mounting plate used on EDFPBM117K and EDFPBM117FPK	–	24	\$202.75
	MP20 [†]	Mounting plate used on EDFPA17C, EDFP217C	–	24	\$202.75
	MP20RA	Mounting plate used on EDFPBM117RAK	–	24	\$202.75
	MP20RA [†]	Mounting plate used on EDFPA17RAC, EDFP217RAC	–	24	\$202.75
	MP85 [†]	Mounting plate used on EDFP10C, EDF14C, EDFP14C	–	5	\$120.00
	MP86	Mounting plate used on EDFPBM114K, EDFPBWM114K and EDFPBM114FPK	–	5	\$120.00
	MP86 [†]	Mounting plate used on EDFP210C, EDFP210RC, EDF214C, EDFP214C, EDF214WC, EDFP214RC	–	5	\$120.00
MP		[†] Not included with base model. Optional accessory only at additional cost.			
	RP2130	Wall bezel will cover wall surface imperfections left when replacing water cooler models HEW, EWA, EWCA with ADA compliant models EZ, EZS, EZO, LZ, LZS and OBF AVR.	–	4	\$96.50
RP2130					
	LKAPR188S	Apron, stainless steel, for use on OBFATL and OBFATLR, not factory installed	–	3	\$93.50
LKAPR188S					
	LKAPR1512	Apron for use on ERHPAM28K, ERHPAM28RAK, LKTEAM8K, LKTEAM8RAK, EDFPA17C, EDFPA17RAC and EDFPA17FPK not factory installed	–	13	\$220.25
LKAPR1512					
	LKAPR1	Apron for use on ERPBM28K, ERPBM28RAK, EDFPBM117C, EDFPBM117RAC and EDFPBM117FPK not factory installed	–	5	\$110.75
LKAPR1					
	LKAPREZL	Apron for use on EZSTL8C, EZTL8C, EZSTL8C, EZTLR8C, not factory installed (only available in gray)	–	2	\$99.25
LKAPREZL					
	97258C	Apron for use on EDFP217C, EDFP217RAC, EDFP217FPK, ERFPM28K, ERFPM28RAK, EROM28K, EROM28RAK, LNTEM8K and LNTEM8RAK not factory installed (only available in black)	–	5	\$110.75
97258C					
	PM3	Post mount shelf with brackets for ER2, ER5, ER10, ERC8 and ERS1	–	11	\$158.50
	PM4	Post mount shelf with brackets for ER19 and ERW20	–	16	\$170.50
PM					
	WP1	Wall plate for use on EDFP10C, EDF14C and EDFP14C single station drinking fountains	–	4	\$111.25
	WP2	Wall plate for Soft Sides® models EDFP210C and EDFP214C single station drinking fountains	–	3	\$111.25
WP					

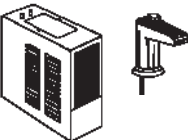
Elkay Accessories

	MODEL NUMBER	FEATURES/OPTIONS	GPH. CAP.	SHIP WT. LBS.	SUG. LIST PRICE
Accessories	LK109A	Glass filler with push lever	-	2	\$115.75
	LK1110	Glass filler with push down control	-	1	\$131.50
	LK1114	Cup and carafe filler	-	2	\$167.75
		LK1114 shown			
Glass Fillers					
LK142	LK142	Bubbler, push-button, lead-free	-	1	\$82.75
	56073C	Flexi-Guard bubbler	-	1/8	\$12.00
56073C					
	97446C	Vandal-resistant bubbler kit and hardware for installation	-	2	\$50.00
97446C					
	LK2156	Aqua-Chill cold water dispenser for use with ERS1 Chiller, order separately	-	1	See current SFL Price List
					
LK2156					

Elkay Filters

WaterSentry® Filter Kits	EWF172	WaterSentry VII Cyst/Lead Reduction and Sediment-Taste-Odor Contains most of the hardware necessary for installation on water coolers and drinking fountains or applications like hot and cold water dispensers, classroom bubblers and glass fillers. Some installations require additional hardware (which can be purchased locally) and some product knowledge.	-	3	\$136.75
					
EWF172					
Replacement Filter Cartridges	51299C	Cyst/Lead Reduction and Sediment-Taste-Odor filter cartridge Replacement cartridge for EWF172	-	2	\$84.25
					
51299C					
In-Line Filter	LF2	In-Line Water Filter. Contains most of the hardware necessary for installation. Some installation requires additional hardware (purchase locally).	-	2	\$101.50
					
LF2					
Filter Cartridge	56192C	Replacement cartridge for LF2	-	1	\$91.75
56192C					
Filter Monitor Kit	92640C*	Filter monitor kit	-	1	\$190.00
92640C					

*Not available in 220-240 volt.

Elkay

2222 Camden Court
Oak Brook, Illinois 60523 U.S.A.
Phone: (630) 574-8484 Fax: (630) 574-5012
Customer Service: (630) 572-3192
www.elkayusa.com