

Installation/Care/Use Manual

EDFA11FPC EDFB12FPC

Freeze Resistant Fountains with FLEXI-GUARD®

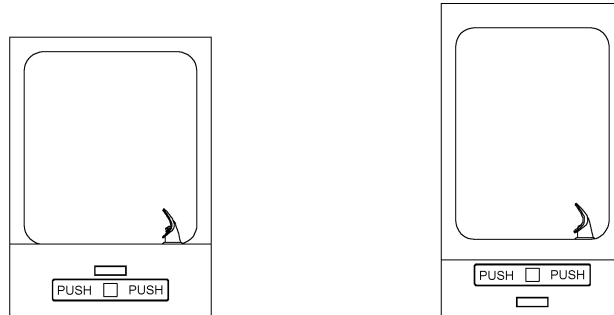

Installer

To assure you install this model easily and correctly, PLEASE READ THESE SIMPLE INSTRUCTIONS BEFORE STARTING THE INSTALLATION. CHECK YOUR INSTALLATION FOR COMPLIANCE WITH PLUMBING, ELECTRICAL AND OTHER APPLICABLE CODES. After installation, leave these instructions inside the fountain for future reference. This Freeze Resistant Fountain is shipped in two separate cartons. The second carton contains the Freeze Resistant Package **LK616A** that is installed on an interior heated wall. Refer to the Freeze Resistant Package for the rough-in dimensions for installation.

IMPORTANT

ALL SERVICE TO BE PERFORMED BY AN AUTHORIZED SERVICE PERSON

IMPORTANT! INSTALLER PLEASE NOTE.

THE GROUNDING OF ELECTRICAL EQUIPMENT SUCH AS TELEPHONE, COMPUTERS, ETC. TO WATER LINES IS A COMMON PROCEDURE. THIS GROUNDING MAY BE IN THE BUILDING OR MAY OCCUR AWAY FROM THE BUILDING. THIS GROUNDING CAN CAUSE ELECTRICAL FEEDBACK INTO A FOUNTAIN, CREATING AN ELECTROLYSIS WHICH CAUSES A METALLIC TASTE OR AN INCREASE IN THE METAL CONTENT OF THE WATER. THIS CONDITION IS AVOIDABLE BY USING THE PROPER MATERIALS AS INDICATED. ANY DRAIN FITTINGS PROVIDED BY THE INSTALLER SHOULD BE MADE OF PLASTIC TO ELECTRICALLY ISOLATE THE FOUNTAIN FROM THE BUILDING PLUMBING SYSTEM.

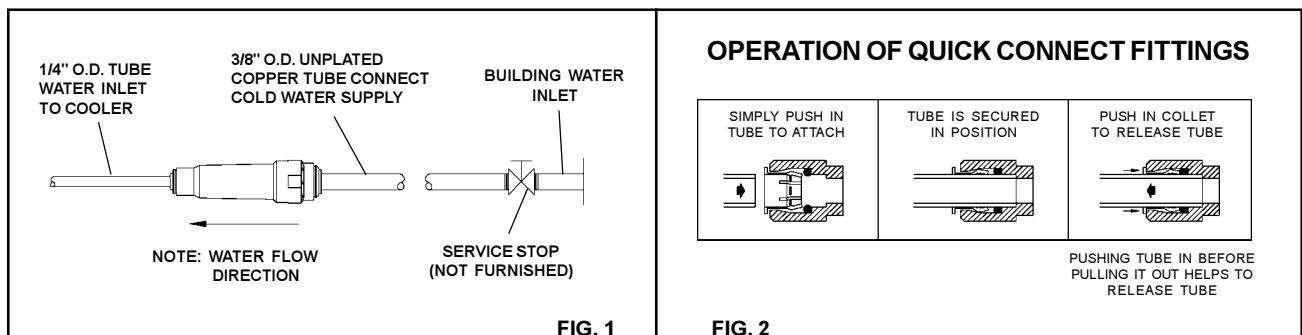

EDFA11FPC ROUGH-IN

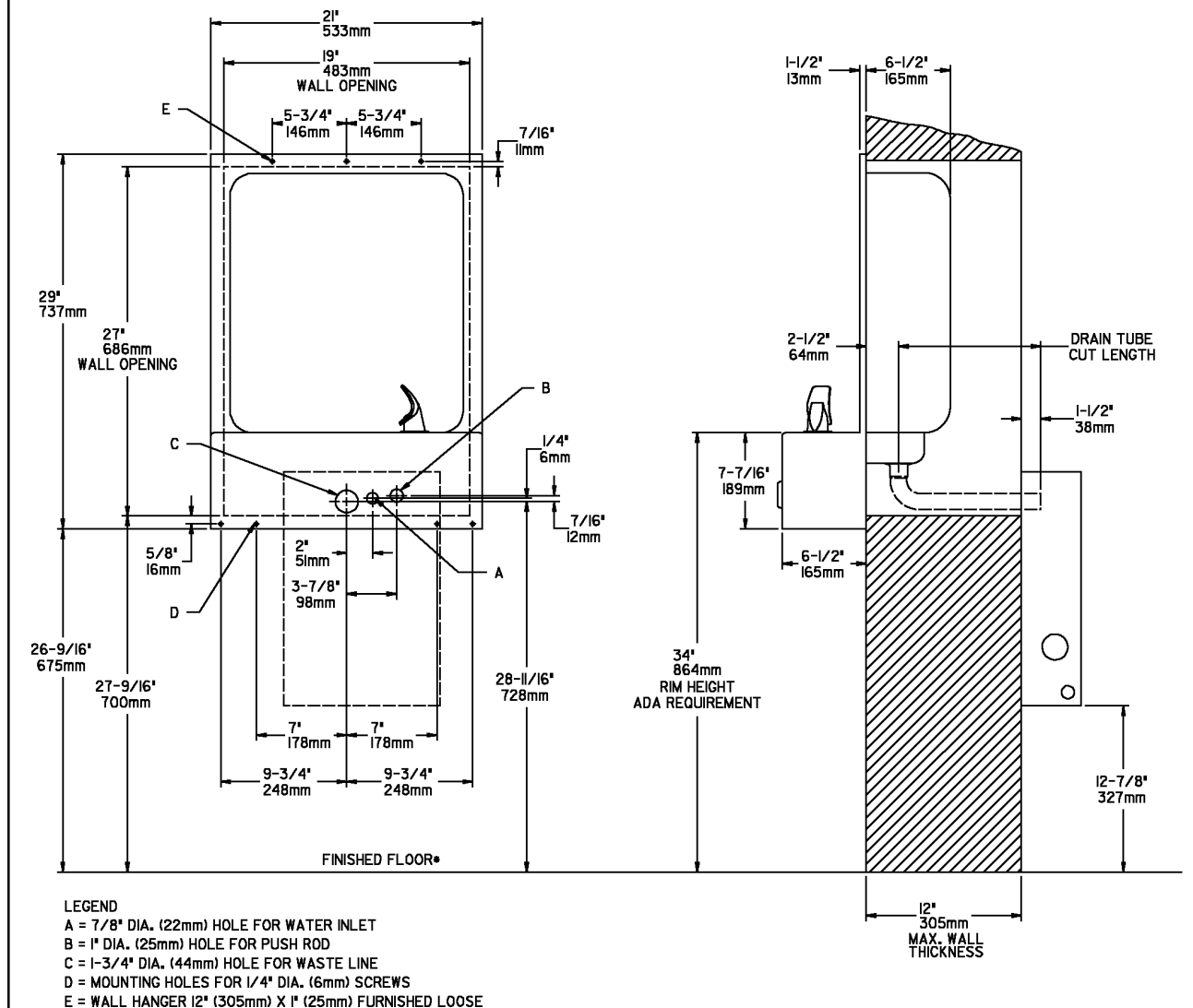

FIG. 3

EDFA11FPC INSTALLATION INSTRUCTIONS

1. Wall should already be framed for the fountain using dimensions shown in Fig. 3.

Shown dimensions pertain to installation location. These dimensions are required for compliance with ANSI Standard A117.1. and ADA.

2. Rough-in wall that freeze resistant box is to be attached to - see box instructions.**3. Attach the hanger bracket to the wall as shown in Fig. 3 . Use bolts and flat washers (not provided). Tighten securely.****4. Cut drain tube** (supplied with freeze resistant box). Length of tube is measured from centerline of the fountain drain to the end of the tube. **Cut length is to be 1" (25mm) less than the wall thickness.****5. Attach push rod** (supplied with freeze resistant box) to push bar assy (item 6) with screw & clip (items 5 & 12). See Fig. 6.**6. Install fountain** by aligning drain tube and push rod with holes in freeze resistant box while hanging the fountain on the hanger bracket. Attach fountain to wall with screws (not provided).**7. Install freeze resistant box** and connect fountain water line to freeze resistant box - see box instructions. Install bottom cover.**8. Install a service stop (not provided)** and make water supply connection from the stop to the strainer in the freeze resistant box. **DO NOT SOLDER TUBES INSERTED INTO THE STRAINER AS DAMAGE TO THE O-RINGS MAY RESULT.**

***NOTE: All dimensions are taken from the finished floor on the side of the wall that the fountain is installed on.**

EDFB12FPC ROUGH-IN

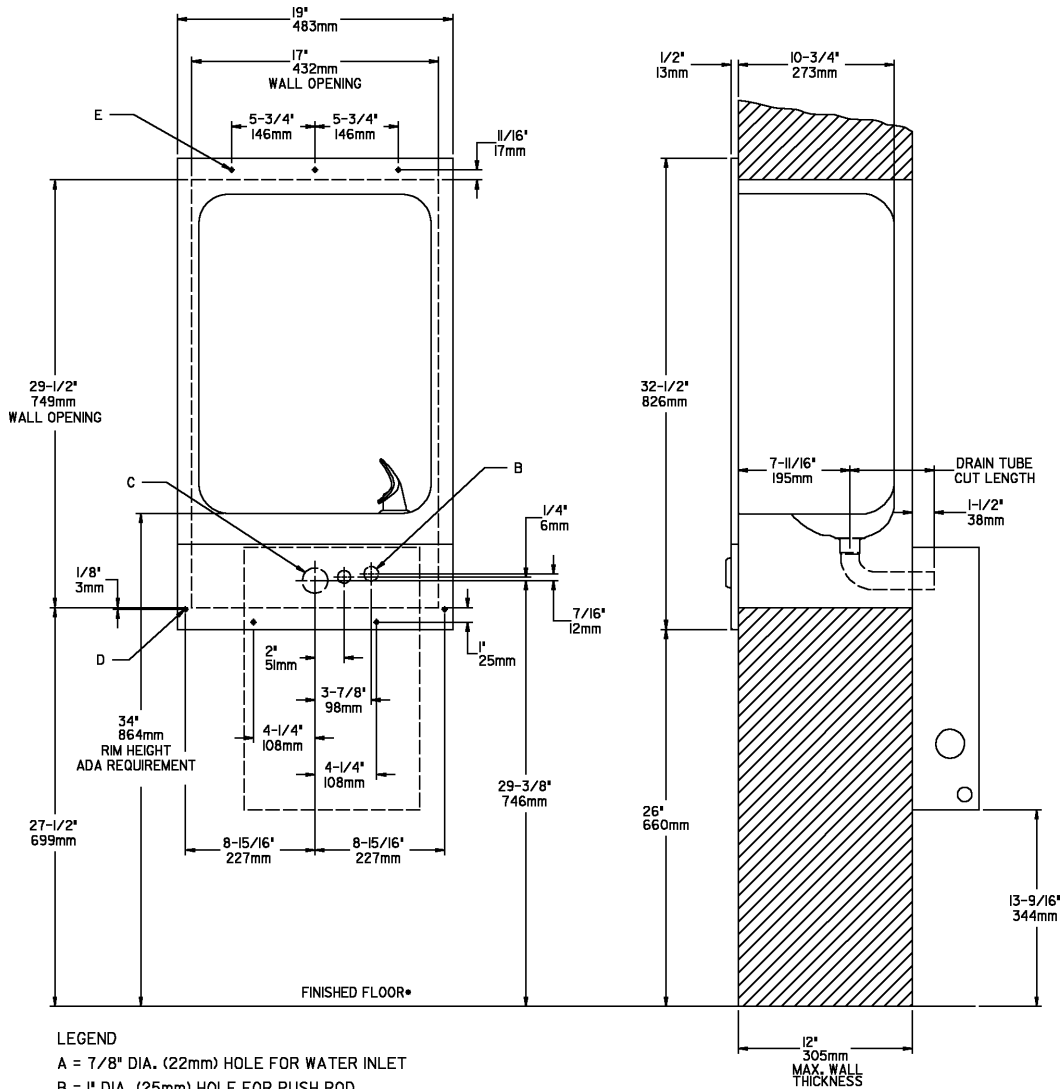

FIG. 4

EDFB12FPC INSTALLATION INSTRUCTIONS

1. Wall should already be framed for the fountain using dimensions shown in Fig. 4.

Shown dimensions pertain to installation location. These dimensions are required for compliance with ANSI Standard A117.1. and ADA.

2. Rough-in wall that freeze resistant box is to be attached to - see box instructions.**3. Attach the hanger bracket to the wall as shown in Fig. 4 . Use bolts and flat washers (not provided). Tighten securely.****4. Cut drain tube** (supplied with freeze resistant box). Length of tube is measured from centerline of the fountain drain to the end of the tube. **Cut length is to be 6-3/16" (157mm) less than the wall thickness.****5. Attach push rod** (supplied with freeze resistant box) to push bar assy (item 6) with screw & clip (items 5 & 12). See Fig. 6.**6. Install fountain** by aligning drain tube and push rod with holes in freeze resistant box while hanging the fountain on the hanger bracket. Attach fountain to wall with screws (not provided).**7. Install freeze resistant box** and connect fountain water line to freeze resistant box - see box instructions. Install bottom cover.**8. Install a service stop (not provided)** and make water supply connection from the stop to the strainer in the freeze resistant box. **DO NOT SOLDER TUBES INSERTED INTO THE STRAINER AS DAMAGE TO THE O-RINGS MAY RESULT.**

*NOTE: All dimensions are taken from the finished floor on the side of the wall that the fountain is installed on.

EDFA11FPC , EDFB12FPC

| PARTS LIST | | |
|------------|----------|---------------------------|
| ITEM NO. | PART NO. | DESCRIPTION |
| 1 | CP11 | COVER PLATE |
| 2 | 55001086 | FOUNTAIN BODY (EDFB12FPC) |
| 3 | 55001097 | FOUNTAIN BODY (EDFA11FPC) |
| 4 | 22912C | BRACKET-PUSH BAR MTG |
| 5 | 21705C | CLIP-PUSH ROD |
| 6 | 21708C | PUSH BAR ASSY-BUFFED |
| 7 | 40322C | ORIFICE ASSY |
| 8 | 55997C | PEDESTAL |
| 9 | 50198C | BSHNG-SNAP .125ID |
| 10 | 56011C | HOUSING ASSEMBLY |
| 11 | 56073C | BUBBLER ASSY |
| 12 | 70002C | SCREW-#10 X .50 HHSM |
| 13 | 75580C | NUT-3/8-18 LKNT |
| 14 | 70018C | NUT-HEX 1/4-20 |
| 15 | 70278C | ROD-SUPPORT |
| 16 | 75555C | CLIP-.125 STUD LOCK |
| NS | 70683C | UNION - 1/4 |

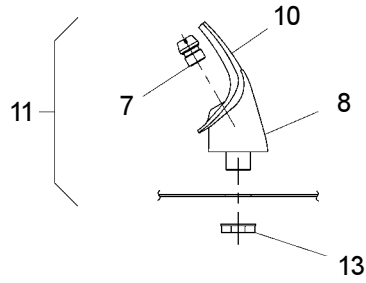

FIG. 5

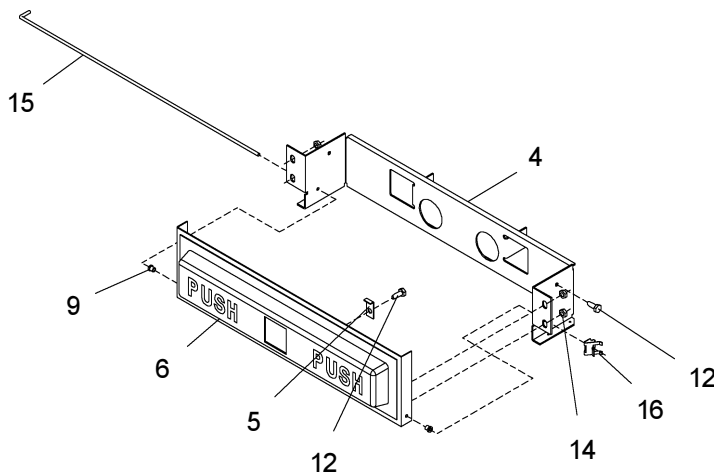
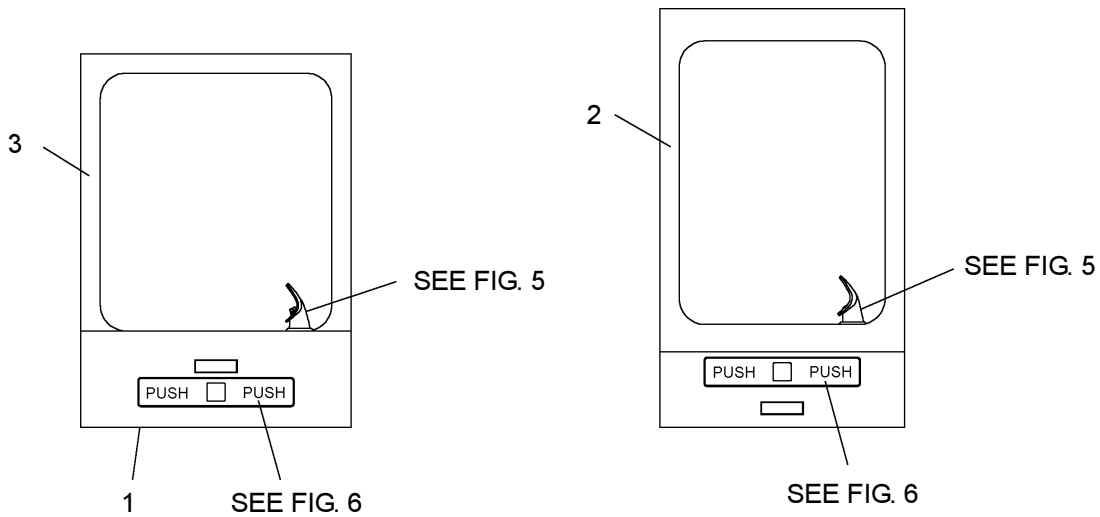

FIG. 6

FOR PARTS, CONTACT YOUR LOCAL DISTRIBUTOR OR CALL 1.800.323.0620
 ELKAY MANUFACTURING COMPANY • 2222 CAMDEN COURT • OAK BROOK, IL 60523 • 630.574.8484